

# ASSEMBLY INFORMATION

for the

elite

## Wine Rack Larder

Soft Closing Full Height Larder Unit - 1700mm

### Contents:

• Parts Required	2
• Assembly Instructions	3
• Assmebly Instructions	4
• Assembly Instructions	5

## Parts Required

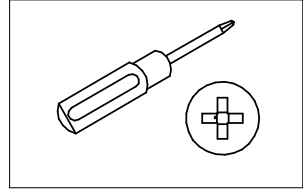
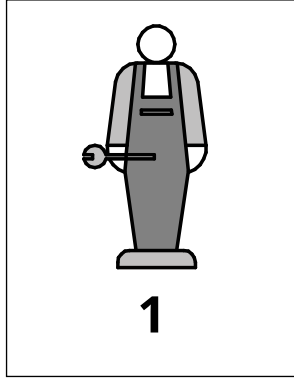
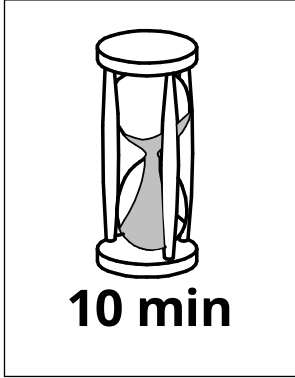
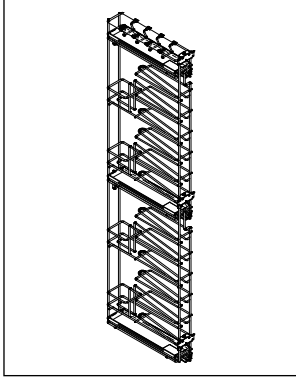

**60kg**  
max load

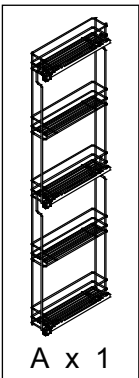
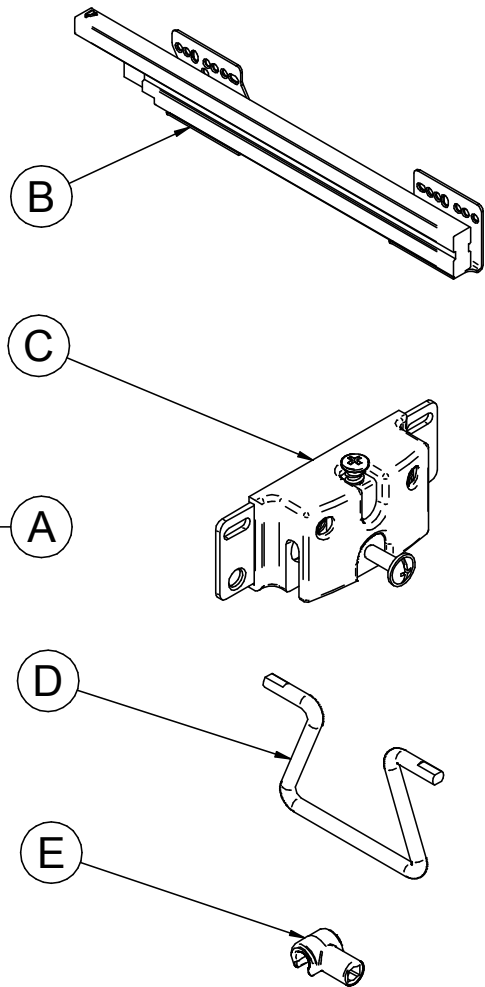
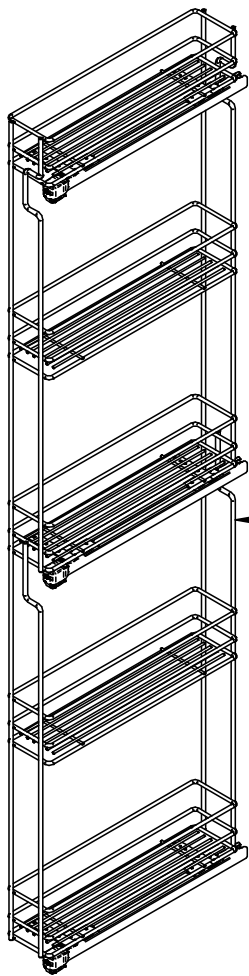

A x 1

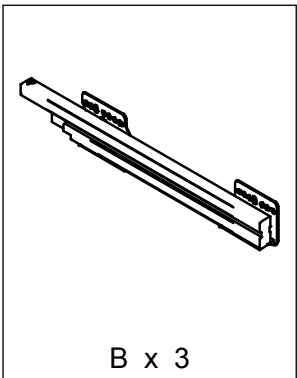

B x 3

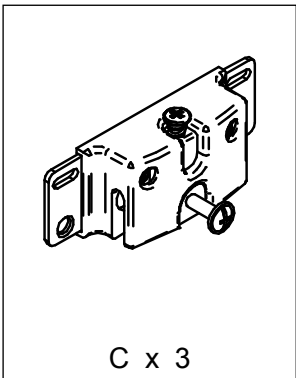

C x 3

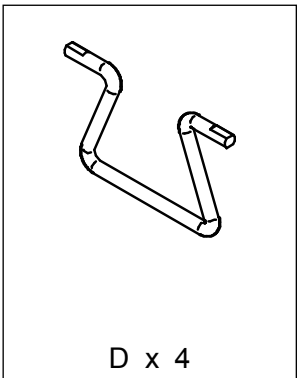

D x 4

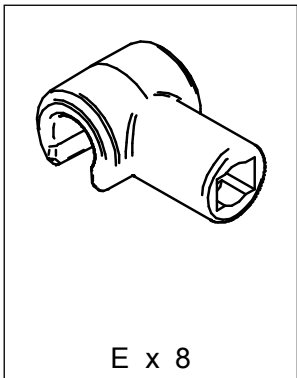

E x 8

## Assembly Instructions

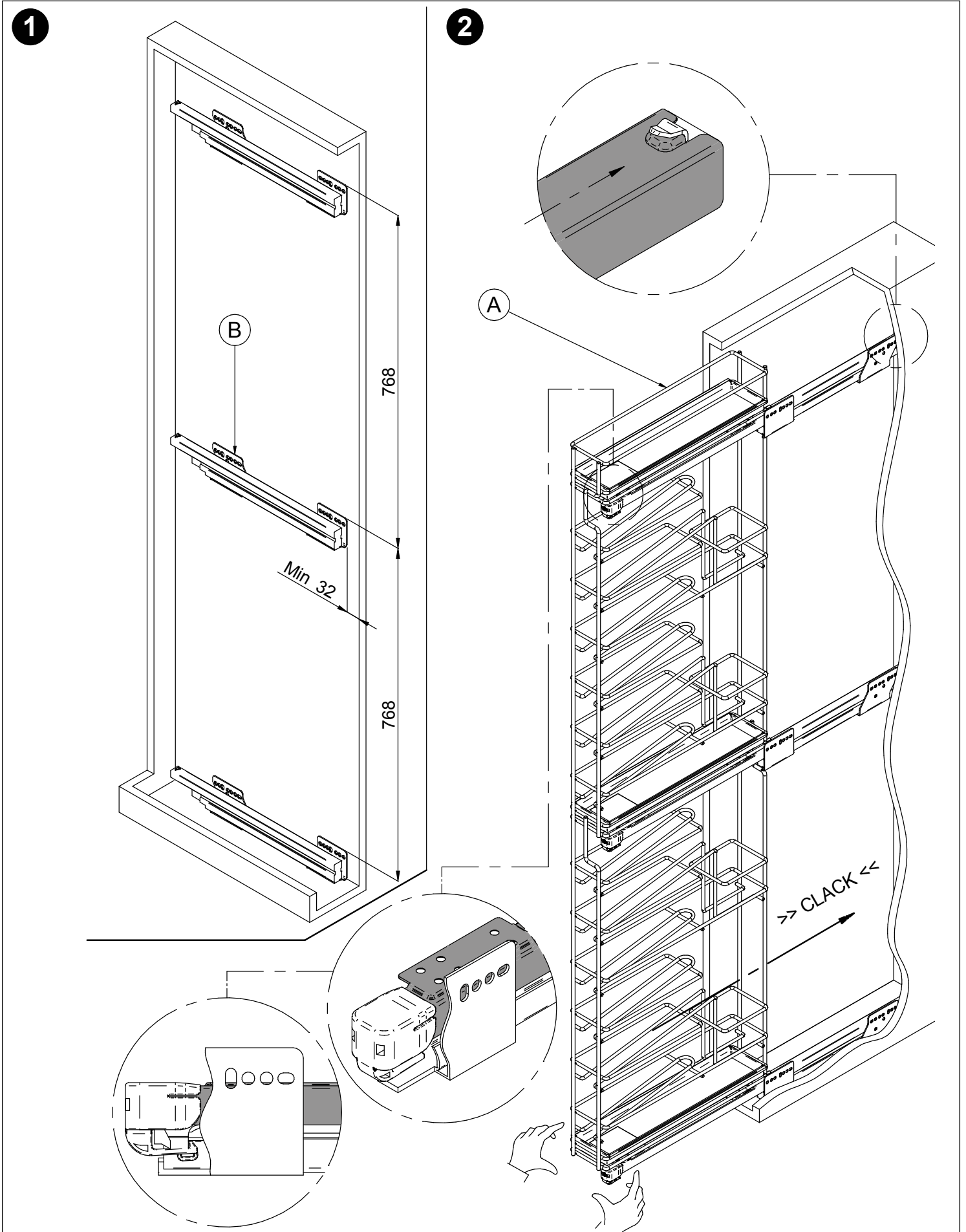

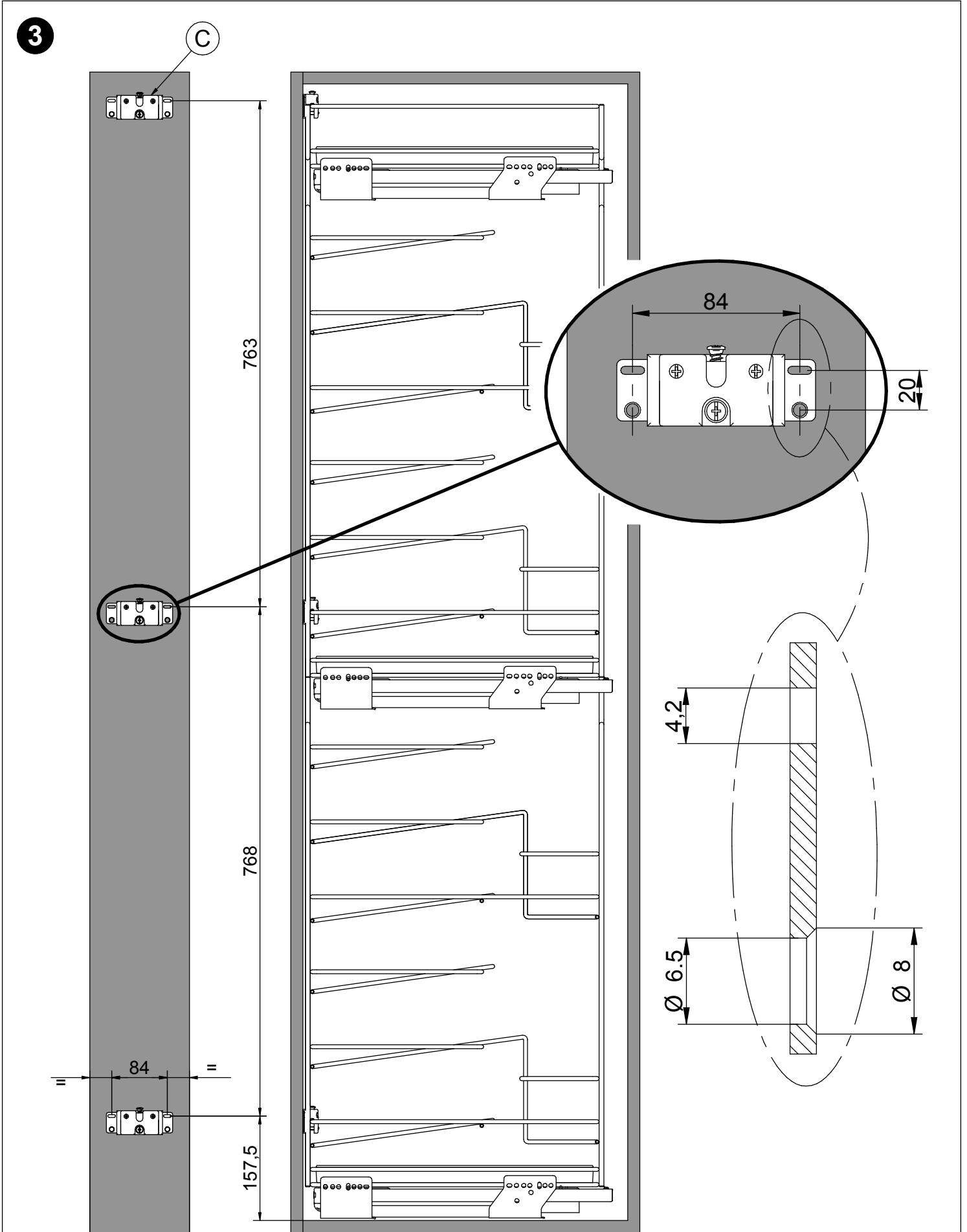

## Assembly Instructions

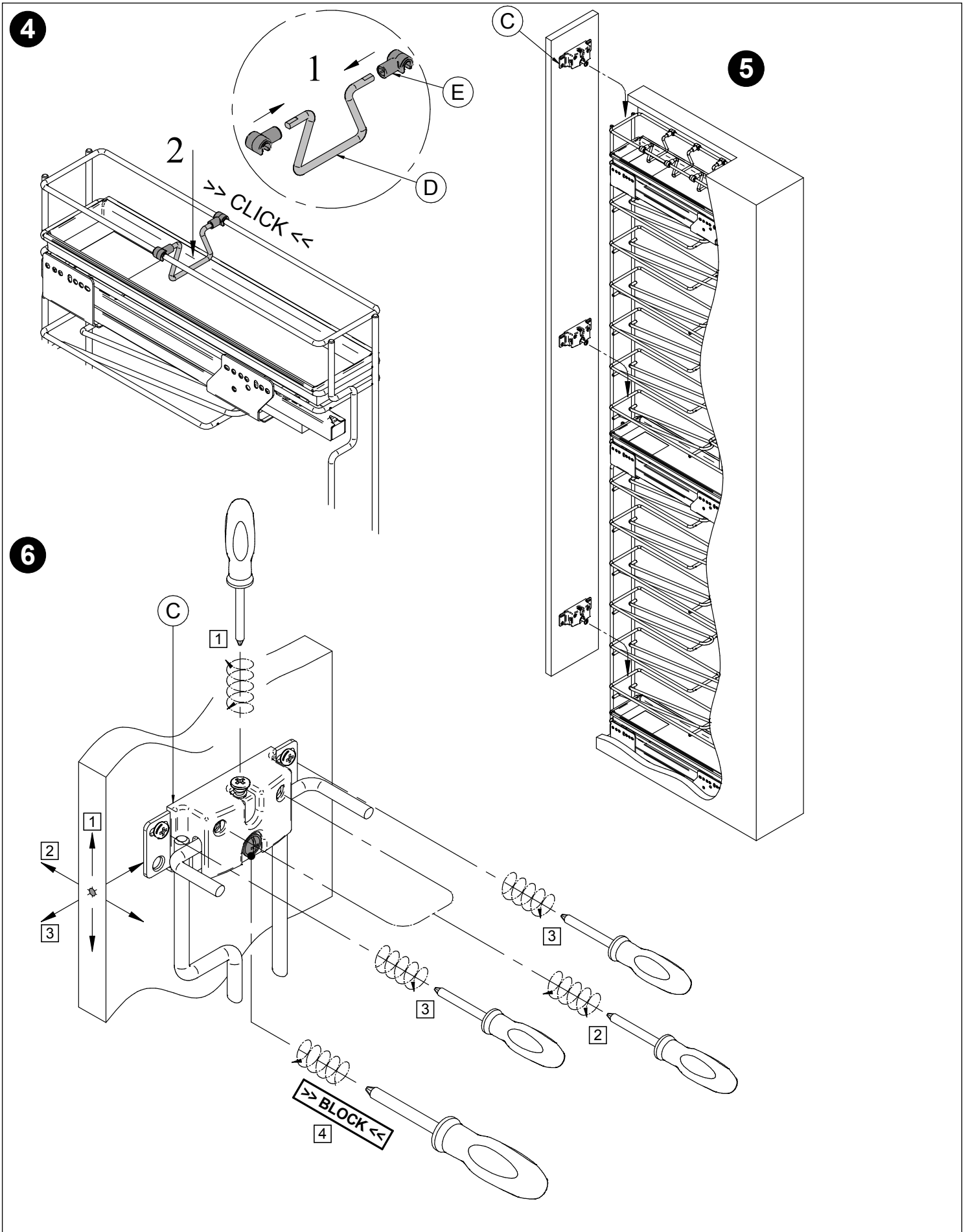



MACHINERY - MATERIALS - COMPONENTS - ADHESIVES - FOILS - PANELS - DOORS

**NEY Ltd (Head Office)**

Stonebridge Trading Estate  
Sibree Road  
Coventry  
CV3 4FD

**t** 024 7630 8100  
**f** 024 7630 8101  
**e** sales@ney.co.uk

**NEY Ireland**

Unit 22 Blaris Ind Estate  
Altona Road  
Lisburn  
BT27 5QB

**t** 028 92 673 000  
**f** 028 92 672 999  
**e** ireland@ney.co.uk

**NEY Scotland**

Block 2 Units 1-2-3  
Bandeath Ind Est  
Throsk, Stirling  
FK7 7NP

**t** 01786 814 814  
**f** 01786 814 812  
**e** scotland@ney.co.uk